

TIPOS DE ENGANCHE:

2100UF

1 POSICION - FIJO

2100UC

4 POSICIONES-CORREDERA

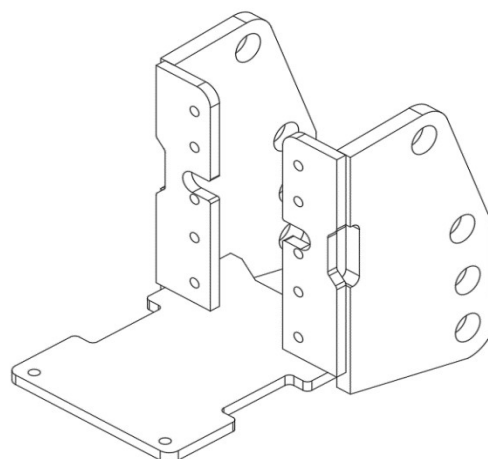
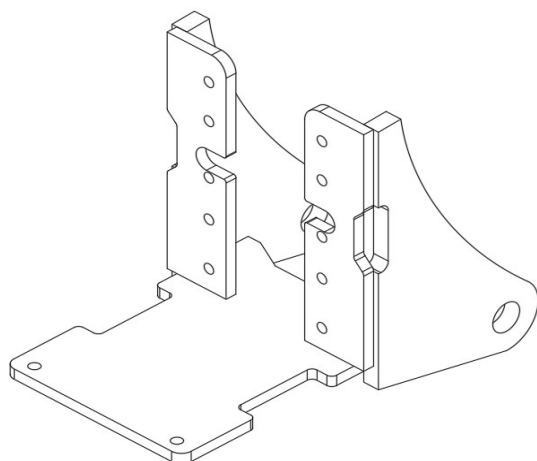

Características Técnicas / Technical data

Fijo / Fixed				Corredera / Slide					
Carga vertical / Vertical load		Carga Horizontal / Horizontal Load		TIPO PETACA (*)		Carga vertical / Vertical load		Carga Horizontal / Horizontal Load	
3000 Kg		85,02 KN		P1LD	(1)	PENDIENTE DE APROBACION ADMINISTRATIVA			
3000 Kg		92,62 KN		P2LD	(1)				
3000 Kg		92,62 KN		P2LDD	(1)				
3000 Kg		92,62 KN		P1LND	(2)				
3000 Kg		96,98 KN		P2LND	(2)				
3000 Kg		96,98 KN		P2LNDD	(2)				
3000 Kg		85,02 KN		PBD80	(3)				

(*) TIPOS DE PETACA: (1) Desmontable / (2) No desmontable / (3) Bola Desmontable

Modelos admitidos / Supported Models

Deutz 5120-Lamborghini R4-Lamborghini Premium 1300- Same Silver (85-120)- Same Antares- Same Silver100.6- Same Explorer3 105

Plano y medidas / Plan and measures

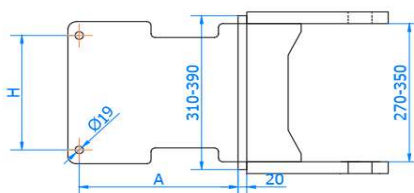
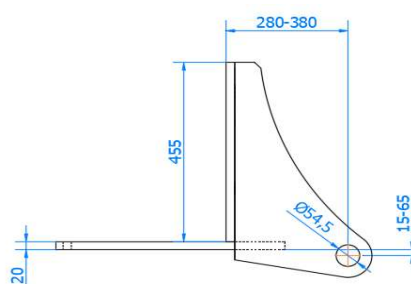
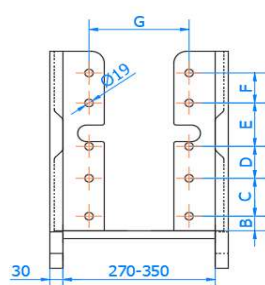

Version	A	B	C	D	E	F	G	H	Petaca	Lateral	Denominacion
2100 A	365	40	96	81	110	76	230	290	320	LU2	R.4
2100 B	225	46	98	88	88	98	230	290	350	LU2	S130 Itv-Italiano
2100 C	335	40	96	81	110	76	230	290	270	LU2	G5 /Atos
2100 D	320	70	56	70	140	56	228	190	290	LU2	Corrado
2100 E	320	70	58	66	140	62	230	190	320	LU2	Tiger
2100 F	320	70	56	71	142	56	230	190	270	LU2	Rakord
2200	325	40	96	81	110	76	230	290	350	LU2	Agroplus
1808	193	32	80	80			226	195	320	LU8	Mc Cormick X5.35

Tornilleria / Bolts		
Tipo /Type	Ud/Ut	Material/Material
M16x50 P200	12	12.9 + Arandela

Observaciones / Observations

(*) Para realizar el pedido indicar la referencia del enganche y el código de la petaca seleccionada. Para otras petacas o accesorios contactar con CELMA EJE A

(*) To order specify the model of coupling and the code of the selected drawbar. For other drawbar types or accessories contact CELMA EJE A

2100C Lamborghini R4

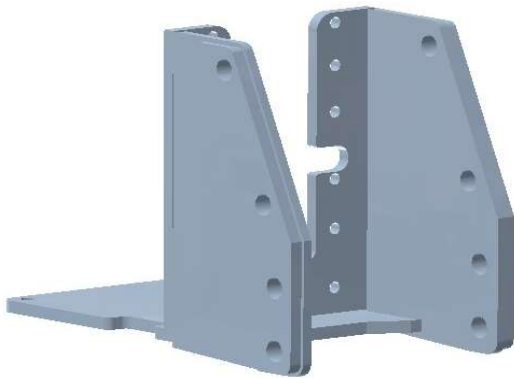





Características Técnicas / Technical data

Denominación / Denomination	1024	2100C
Tipo / Type	Corredera / Slide	
Carga vertical / Vertical load	3.000 kg /	2.943 dN
Carga Horizontal / Horizontal Load	19.000 kg /	19,00 t

Modelos admitidos / Supported Models

Lamborghini R4- Premium 1300
Same Silver (85-120)- Antares- Silver100.6- Explorer3 105
Deutz 5120

Accesorios Normalizados / Standard Accessories (*)

ID	Denominación / Denomination	Imagen/Image	Observaciones/Observations
PCDS	Petaca oscilante corredera doble Double Swinging drawbar slide		Diametro bulón < 40 mm Diameter pin < 40 mm
PCDR	Petaca corredera doble Reforzada Double Swinging drawbar slide and reinforced		Diametro bulón > 40 mm Diameter pin > 40 mm
PCDD	Petaca oscilante corredera doble descentrada Double Swinging drawbar slide and off-centre		Diametro bulón < 40 mm Diameter pin < 40 mm
ADBO80	Adaptador de bola 80 mm 80mm ball Adapter		
ADCLAV	Adaptador de clavija Bolt Adapter		

Plano y medidas / Plan and measures

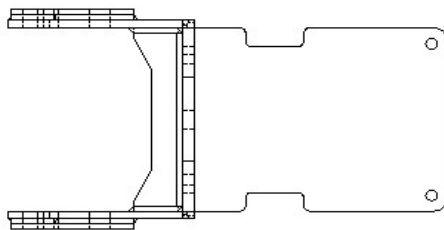
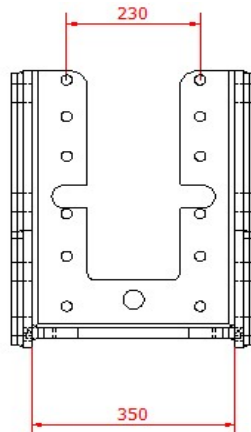
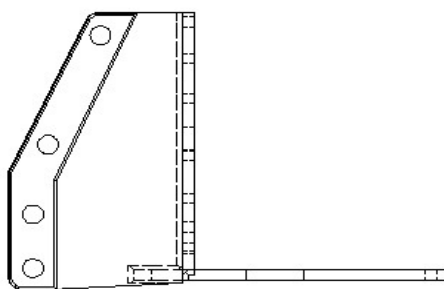

Tornillería / Bolts

Tipo /Type	Ud/Ut	Material/Material
M16x50 P200	14	12.9

Observaciones / Observations

(*) Para realizar el pedido indicar la referencia del enganche y el código de la petaca seleccionada. Para otras petacas o accesorios contactar con CELMA EJE A
(*) To order specify the model of coupling and the code of the selected drawbar. For other drawbar types or accessories contact CELMA EJE A