

1004C MX media

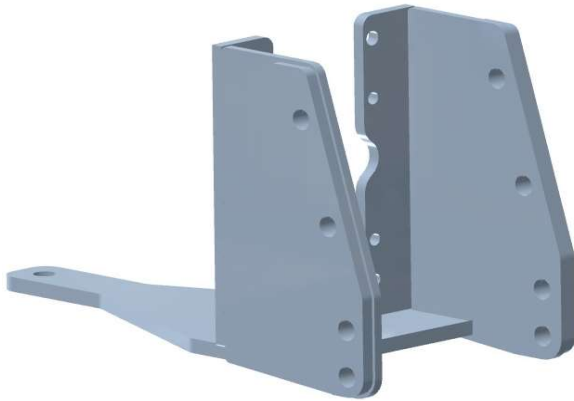

Características Técnicas / Technical data





Denominación / Denomination	1253	1004C
Tipo / Type	Corredera / Slide	
Carga vertical / Vertical load	3.000 kg /	2.943 dN
Carga Horizontal / Horizontal Load	16.600 kg /	16,60 t

Modelos admitidos / Supported Models

Case MX (150-175)

Mc Cormick MTX (150-200)

Accesorios Normalizados / Standard Accessories (*)

ID	Denominación / Denomination	Imagen/Image	Observaciones/Observations
PCDS	Petaca oscilante corredera doble Double Swinging drawbar slide		Diametro bulón < 40 mm Diameter pin < 40 mm
PCDR	Petaca corredera doble Reforzada Double Swinging drawbar slide and reinforced		Diametro bulón > 40 mm Diameter pin > 40 mm
PCDD	Petaca oscilante corredera doble descentrada Double Swinging drawbar slide and off-centre		Diametro bulón < 40 mm Diameter pin < 40 mm
ADBO80	Adaptador de bola 80 mm 80mm ball Adapter		
ADCLAV	Adaptador de clavija Bolt Adapter		

Plano y medidas / Plan and measures

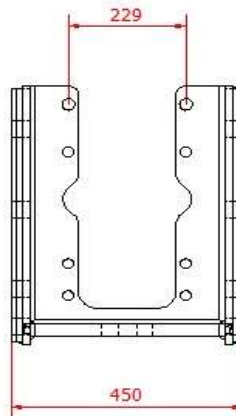
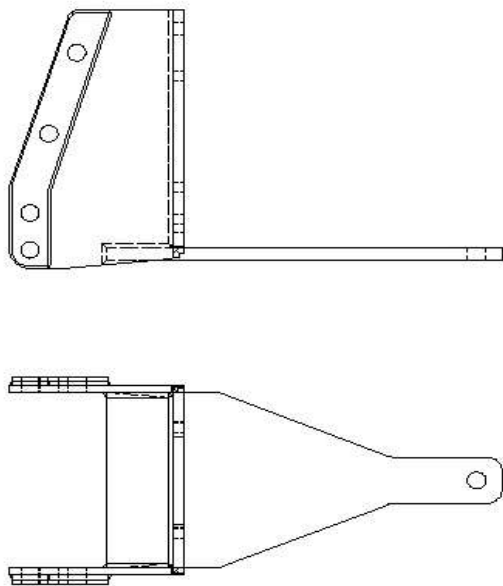

Tornillería / Bolts

Tipo /Type	Ud/Ut	Material/Material
M18x60 P250	6	12.9
M20x170 P250	2	12.9

Observaciones / Observations

(*) Para realizar el pedido indicar la referencia del enganche y el código de la petaca seleccionada. Para otras petacas o accesorios contactar con CELMA EJE A

(*) To order specify the model of coupling and the code of the selected drawbar. For other drawbar types or accessories contact CELMA EJE A

1004F MX Media



Características Técnicas / Technical data







Denominación / Denomination	1252	1004F
Tipo / Type	Fijo / Fixed	
Carga vertical / Vertical load	3.000 kg /	2.943 dN
Carga Horizontal / Horizontal Load	24.300 kg /	24,30 t

Modelos admitidos / Supported Models

Case MX (150-175)

Mc Cormick MTX (150-200)

Accesorios Normalizados / Standard Accessories (*)

ID	Denominación / Denomination	Imagen/Image	Observaciones/Observations
PFDS	Petaca oscilante fija doble Double Swinging drawbar fixed		Diametro bulón < 40 mm Diameter pin < 40 mm
PFDR	Petaca fija doble Reforzada Double Swinging drawbar fixed and reinforced		Diametro bulón > 40 mm Diameter pin > 40 mm
PFDD	Petaca oscilante fija doble descentrada Double Swinging drawbar fixed and off-centre		Diametro bulón < 40 mm Diameter pin < 40 mm
PFUS	Petaca oscilante fija simple Simple Swinging drawbar fixed		Diametro bulón < 40 mm Diameter pin < 40 mm
PFUR	Petaca oscilante fija doble Double Swinging drawbar fixed		Diametro bulón < 40 mm Diameter pin < 40 mm
ADCLAV	Adaptador de clavija Bolt Adapter		
ADBO80	Adaptador de bola 80 mm 80mm ball Adapter		

Plano y medidas / Plan and measures

Tornillería / Bolts

Tipo /Type	Ud/Ut	Material/Material
M18x60 P250	6	12.9
M20x170 P250	2	12.9

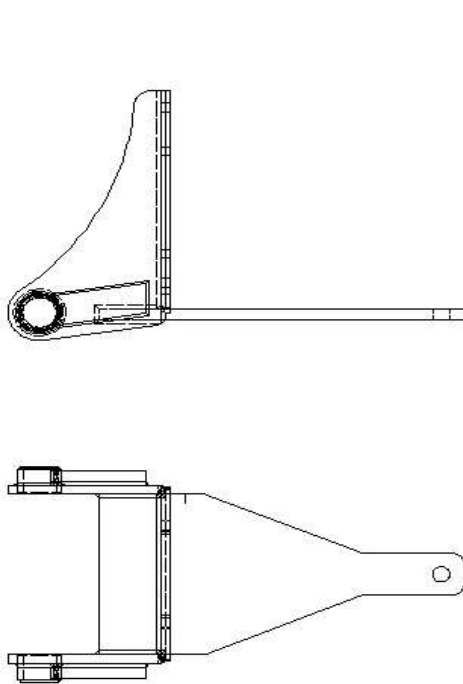

Observaciones / Observations

(*) Para realizar el pedido indicar la referencia del enganche y el código de la petaca seleccionada. Para otras petacas o accesorios contactar con CELMA EJE A

(*) To order specify the model of coupling and the code of the selected drawbar. For other drawbar types or accessories contact CELMA EJE A