







TIPOS DE ENGANCHE:
1403UF
1 POSICION - FIJO
1403UC
4 POSICIONES-CORREDERA

Características Técnicas / Technical data

Fijo / Fixed			Corredera / Slide		
Carga vertical / Vertical load	Carga Horizontal / Horizontal Load	TIPO PETACA (*)	Carga vertical / Vertical load	Carga Horizontal / Horizontal Load	
3000 Kg	85,02 KN	P1LD  (1)	3000 Kg	85,02 KN	
3000 Kg	92,62 KN	P2LD  (1)	3000 Kg	92,62 KN	
3000 Kg	92,62 KN	P2LDD  (1)	3000 Kg	92,62 KN	
3000 Kg	92,62 KN	P1LND  (2)	Kg	KN	
3000 Kg	96,98 KN	P2LND  (2)	Kg	KN	
3000 Kg	96,98 KN	P2LNDD  (2)	Kg	KN	
3000 Kg	85,02 KN	PBD80  (3)	3000 Kg	85,02 KN	

(*) TIPOS DE PETACA: (1) Desmontable / (2) No desmontable / (3) Bola Desmontable

Modelos admitidos / Supported Models

John Deere (de 6100 a 6630)-(de 6115M a 6140M)-(de 6105R a 6115R)

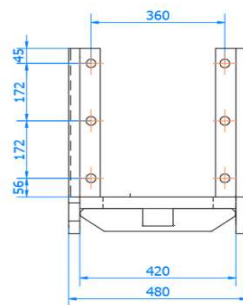
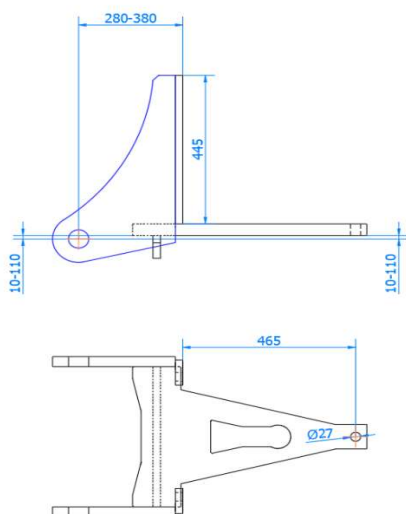
Plano y medidas / Plan and measures
Tornilleria / Bolts

Tipo /Type	Ud/Ut	Material/Material
M20x60 P250	6	12.9

Observaciones / Observations

(*) Para realizar el pedido indicar la referencia del enganche y el código de la petaca seleccionada. Para otras petacas o accesorios contactar con CELMA EJE A

(*) To order specify the model of coupling and the code of the selected drawbar. For other drawbar types or accessories contact CELMA EJE A